

SINGLE SPARE PARTS LIST			
ITEM	QTY	PART NUMBER	DESCRIPTION
40	2	00000406	Top_Clamp_Nut_R6_M6
41	2	00000427	Screw_Washer_R8
42	1	00000415	Back_Screw_M6
43	1	00000404	Front_Screw_M6
44	1	00000694	H01_seatclamp set
45	1	00000402	Bottom_Clamp
47	1	00000416	H01_Height_Adjustment_Pin
105	1	00000414	H01_Bowden_Insert

TOTAL UNIT - MAINTUBE + HEAD	
PART NUMBER	DESCRIPTION
00000700	H01 Maintube+head 4X-S w/o clamping parts
00000701	H01 Maintube+head 4X-M w/o clamping parts
00000702	H01 Maintube+head 4X-L w/o clamping parts
00000703	H01 Maintube+head 4X-XL w/o clamping parts
00000704	H01 Maintube+head 6X-XS w/o clamping parts
00000705	H01 Maintube+head 6X-S w/o clamping parts
00000706	H01 Maintube+head 6X-M w/o clamping parts
00000707	H01 Maintube+head 6X-L w/o clamping parts
00000708	H01 Maintube+head 6X-XL w/o clamping parts
00000709	H01 Maintube+head 6X-XXL w/o clamping parts

E-E ( 1 : 2 )

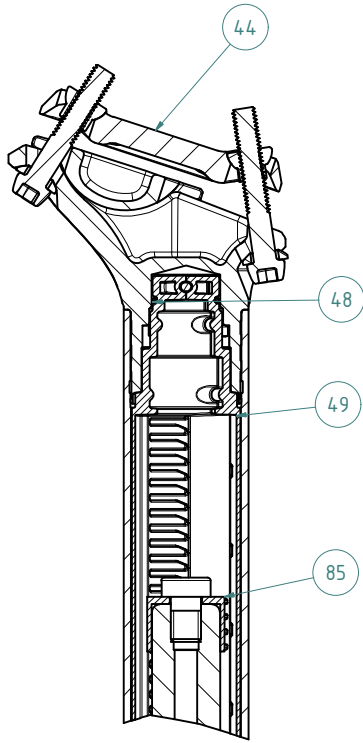
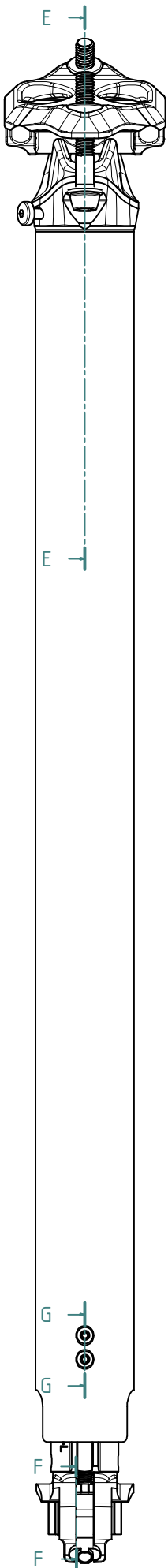

PARTS LIST			
ITEM	QTY	PART NUMBER	DESCRIPTION
44	1	00000694	H01 seatclamp set
48	1	00000442	H01_Top_O_Ring
49	2	00000693	H01 grid shell set
50	2	00000695	H01 guiding insert set
51	4	00000410	H01_Guiding_Screw
74	1	00000405	H01_Bottom_Spring_Lever
75	1	00000448	H01_TOP_BUSHING
76	2	DIN 915 - M4 x 6	Hexagon Socket Set Screw
85	1	00000450	H01_Height_Adjust_Part
89	1	00000608	H01_HGS-Release_spring
91	1	DIN 7984 - M8 x 12	Cylinder Head Cap Screw
105	1	00000414	H01_Bowden_Insert

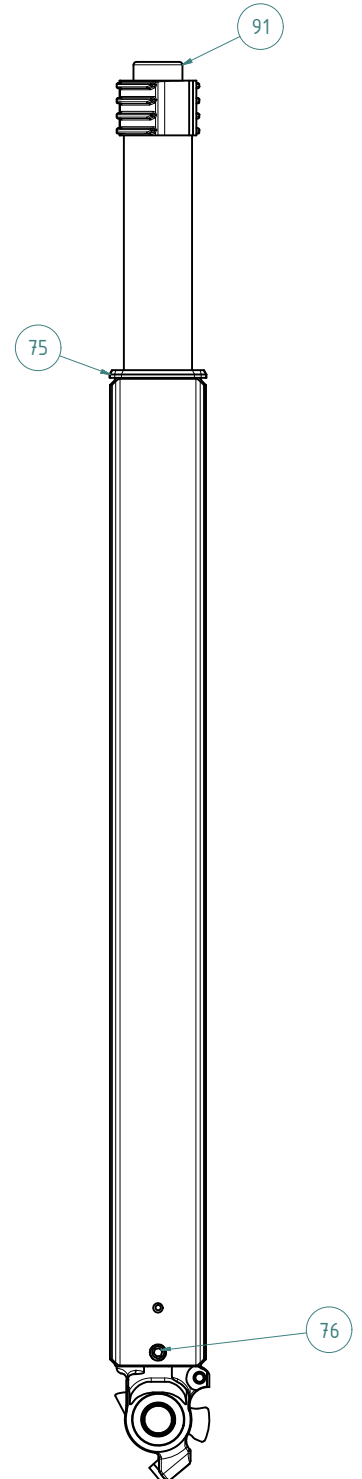

G-G ( 1 : 2 )

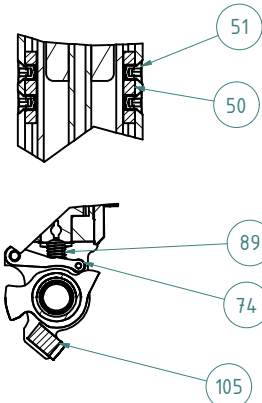

F-F ( 1 : 2 )

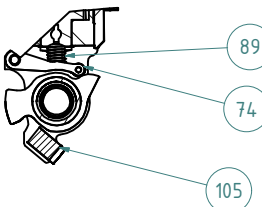

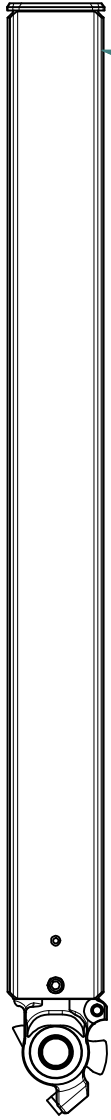

TOTAL UNIT ASSEMBLED	
PART NUMBER	DESCRIPTION
00000571	H01_Torque_Tube_Main_Adapter_6X_L_COMP
00000572	H01_Torque_Tube_Main_Adapter_4X_L_COMP
00000573	H01_Torque_Tube_Main_Adapter_4X_L
00000574	H01_Torque_Tube_Main_Adapter_6X_XL_COMP
00000575	H01_Torque_Tube_Main_Adapter_4X_M_COMP
00000576	H01_Torque_Tube_Main_Adapter_6X_XS_COMP
00000579	H01_Torque_Tube_Main_Adapter_4X_S_COMP
00000582	H01_Torque_Tube_Main_Adapter_6X_S_COMP
00000583	H01_Torque_Tube_Main_Adapter_6X_M_COMP
00000585	H01_Torque_Tube_Main_Adapter_6X_XXL_COMP

TOTAL UNIT - HYDRAULIC GAS SPRING	
PART NUMBER	DESCRIPTION
00000698	H01 HGS 4X-S replacement set
00000699	H01 HGS 4X-M replacement set
00000710	H01 HGS 4X-L replacement set
00000711	H01 HGS 4X-XL replacement set
00000712	H01 HGS 6X-XS replacement set
00000713	H01 HGS 6X-S replacement set
00000714	H01 HGS 6X-M replacement set
00000715	H01 HGS 6X-L replacement set
00000716	H01 HGS 6X-XL replacement set
00000717	H01 HGS 6X-XXL replacement set

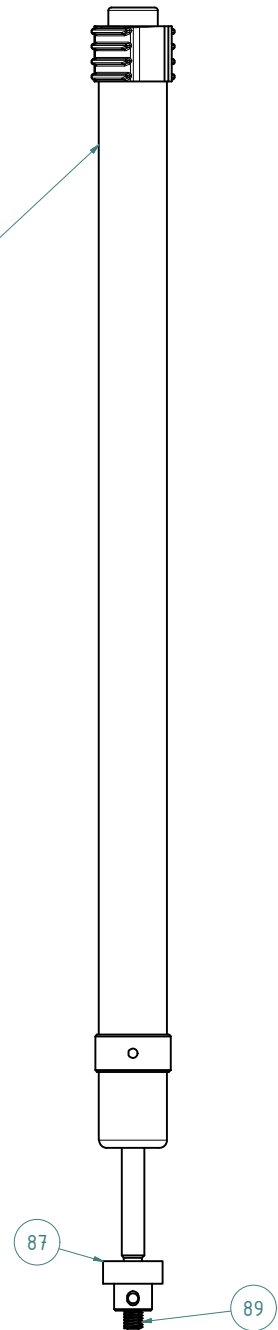

SINGLE SPARE PARTS LIST			
ITEM	QTY	PART NUMBER	DESCRIPTION
87	1	00000444	H01_Piston_Rod_Adapter
89	1	00000608	H01_HGS-Release_spring